

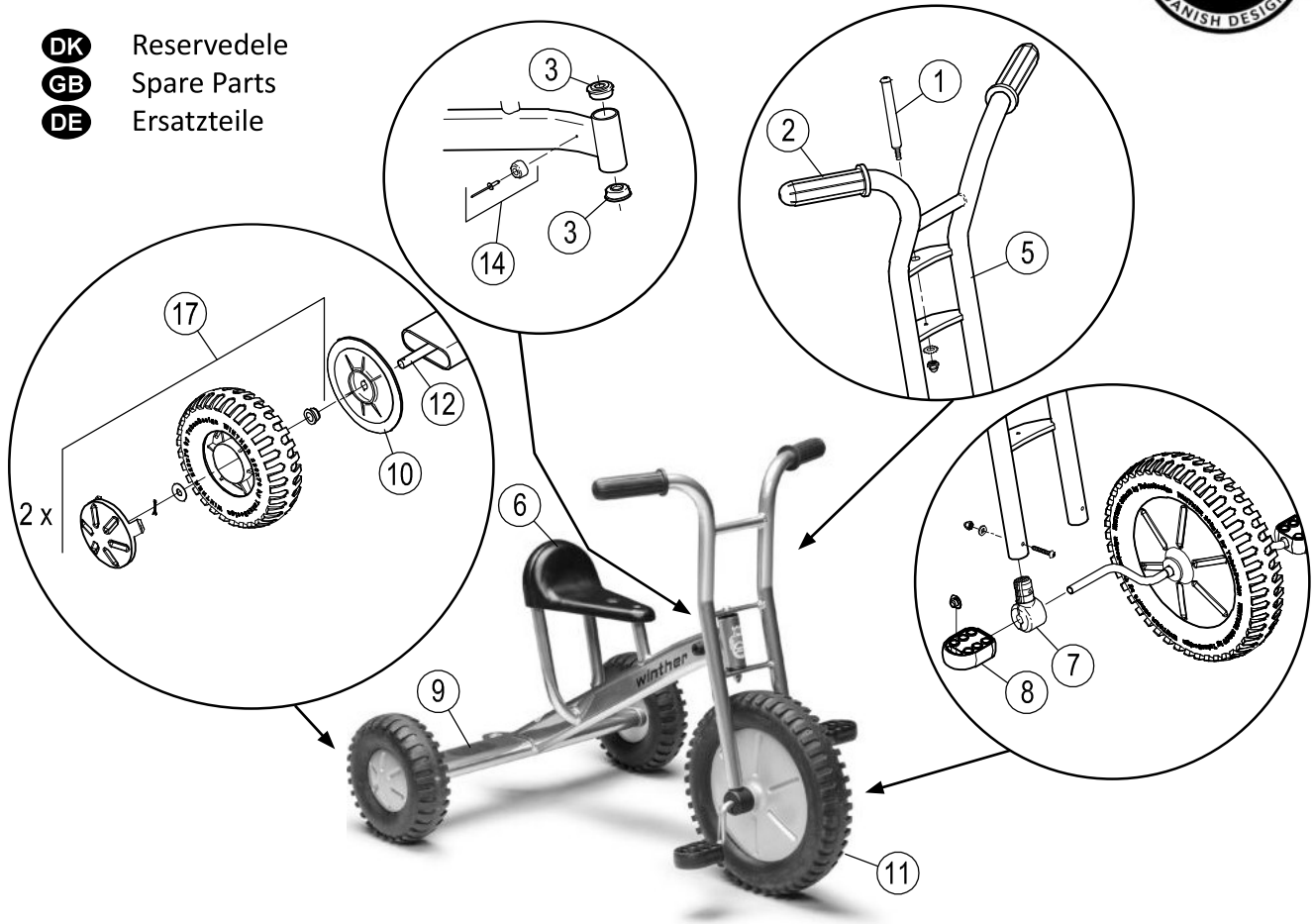

























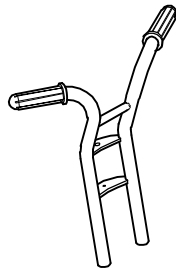













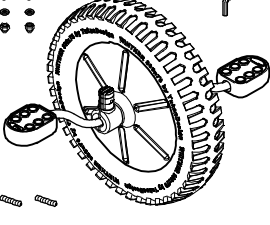









452.74



- DK** Reservedele
- GB** Spare Parts
- DE** Ersatzteile

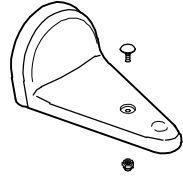
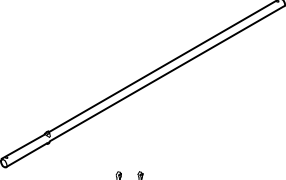

Pos.		Pos.		Pos.	
1	 x1  x2  x1	7	 x2  x2  x2  x2  x1	13	
2	 x2  x2	8	 x2  x2	14	 x2  x2
3	 x2	9	 x2	15	
4		10	 x2	16	
5	             	11	         	17	       
6		12		18	



452.74



- DK** Reservedele
- GB** Spare Parts
- DE** Ersatzteile

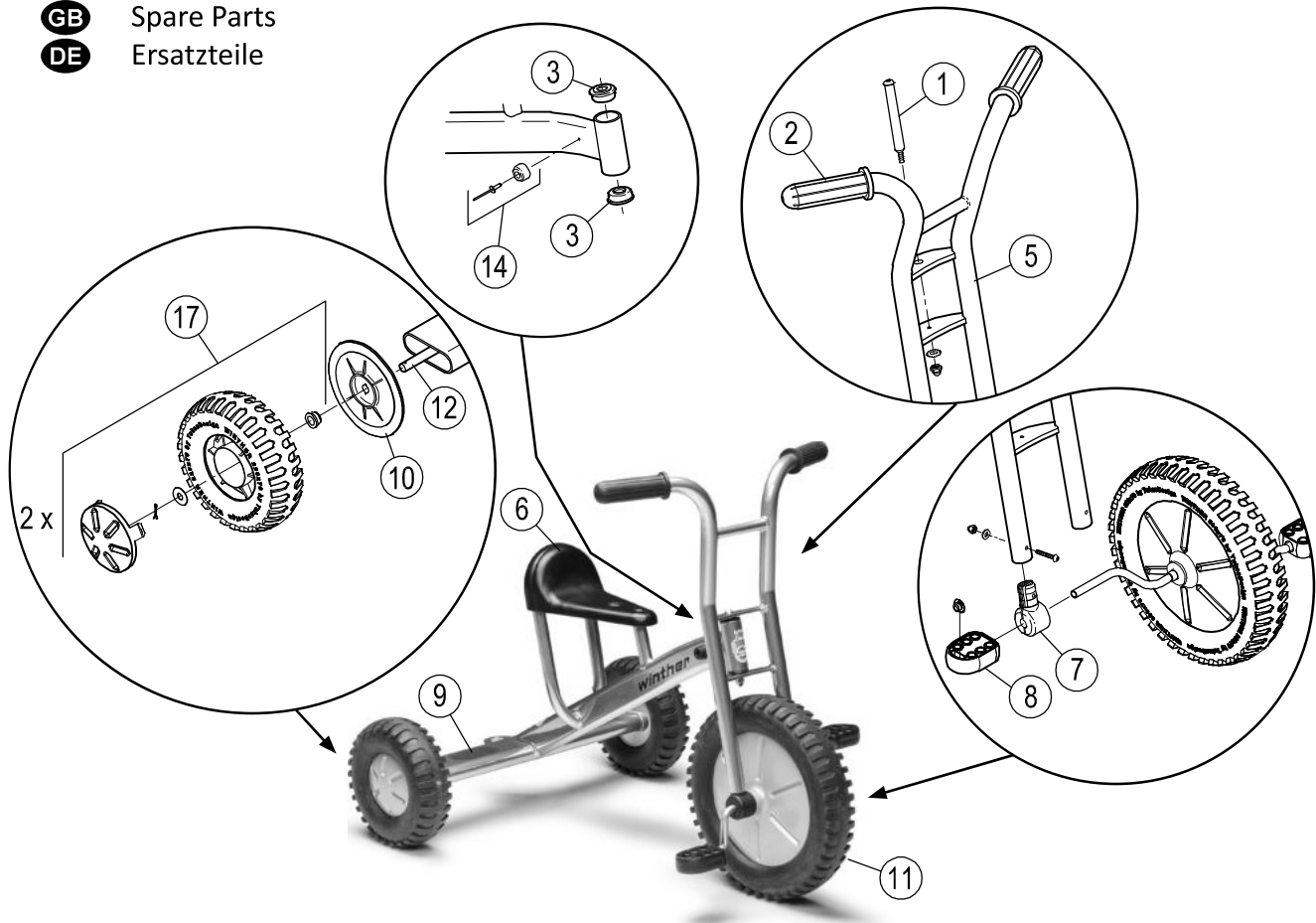

452.74					
Version					
Pos.	1.0				
1	50501				
2	50503				
3	50504				
4	-				
5	50749				
6	50580				
7	50506				
8	50510				
9	50511				
10	50750				
11	50781				
12	50753				
13	-				
14	50531				
15	-				
16	-				
17	50754				
18	-				