

NORA SWING FRAME FOR A BIRDNEST SEAT, LOW

Prime , F24407M

The Nora swing frame with a bird's nest seat lets children experience the joy of swinging together. The large nest-shaped seat accommodates several children at the same time, supporting shared play, rhythm, and social participation. Nora is intended for children aged 1 year and older and is made of a strong steel beam and a PEFC-certified pine frame. Designed for long-term use in public playgrounds, schoolyards, and recreational areas, its open design ensures easy access and allows all children to take part in play regardless of ability. Maximum fall height is 1,200 mm.

Basic information

User Age	+1
Number of Users	4
Installation Time	6
Safety Standard	EN 1176-1:2017; 2

Technical information

Amount of Concrete, m ³	0.36	Impact Area, m ²	19
Largest Part, mm	2945	Max Free Fall Height, PLAY, mm	1200
Netto Weight, Total Shipping Weight, kg	188.514	Minimum Space/Height, mm	2820
Foundation Type	Deep mounting, Surface mounting	Safety Area, Length, mm	2450
Heaviest part, kg	47	Width, mm	1500
Falling Space, Length, mm	2450	Falling Space, Width, mm	7790
Falling Space, m ²	19	Length, mm	3770
Height, mm	2320	Safety Area, Width, mm	7790

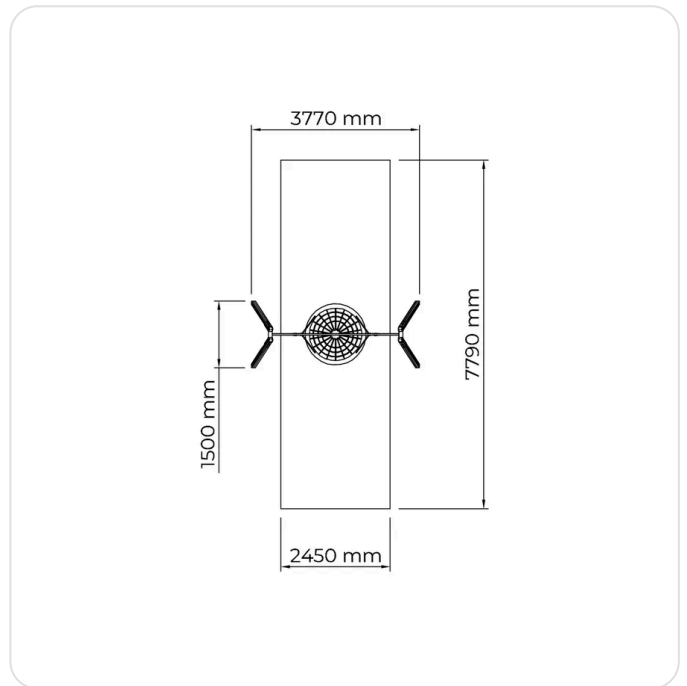
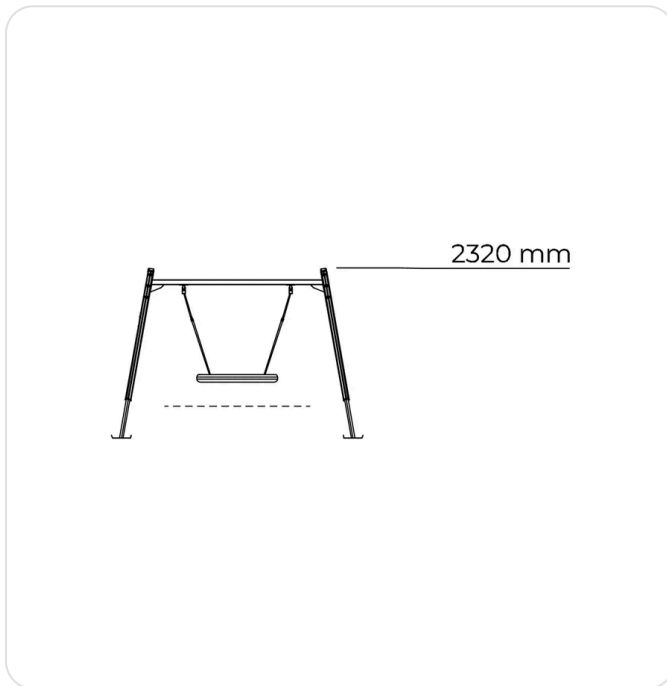

[Installation instructions: https://lap-integrations-prod.azurewebsites.net/api/pim/installation-instructions?productN...](https://lap-integrations-prod.azurewebsites.net/api/pim/installation-instructions?productN...)

[Read more about installation: https://www.lappset.com/en-GB/playground-installation](https://www.lappset.com/en-GB/playground-installation)



General warranty information

- **20 years:** Steel components and high-pressure laminate (HPL)
- **15 years:** Wooden posts
- **10 years:** Surface finish of steel and aluminum, and hot-dip galvanized surface treatment
- **10 years:** Guaranteed availability of spare parts
- The general warranty terms do not apply to third-party products.
- This overview covers the main warranty periods for Lappset's key materials.



For full details and specific terms or limitations, please see the complete warranty conditions [here](#).

 Read more about warranty: <https://www.lappset.com/en-GB/warranty>

Wooden posts

-  Preserved pine, natural tone
-  Platinum grey
-  Premium brown

Metal parts

-  Lemonade yellow RAL 1018
-  Platinum grey NCS S4005-Y50R