

Configurable

MEADOW

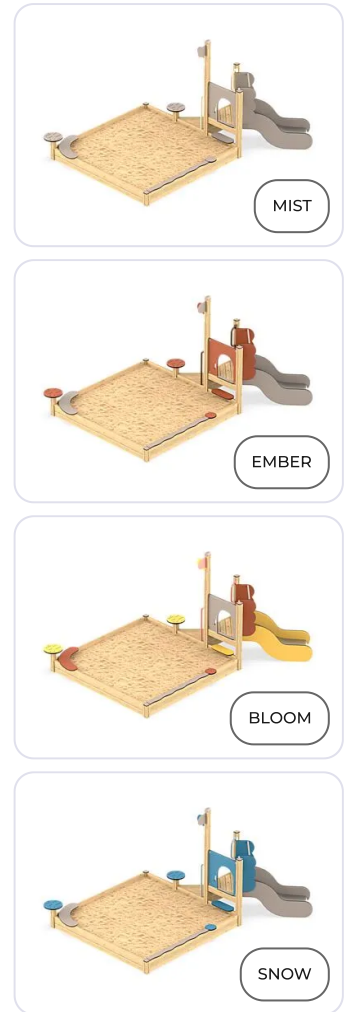

MIST

EMBER

BLOOM

SNOW

Oiva Toddler Play Tower

Prime , F24606M

Oiva Sandbox with Play Tower does exactly what it says. It combines the kindergarten classics to a one cohesive solution. The toddler slide is easily accessible via the platforms or the Small crawling gate. The sandbox sides have multiple platforms and even a wobbly side, which is excellent especially when playing with toy cars or other vehicles. The product is manufactured from PEFC-certified Nordic pine. Colorful panels are HPL.

Basic information

User Age	1+
Number of Users	10
Safety Standard	EN 1176-1:2017

Play functions

✖ PLAY WALLS **1**

Technical information

Largest Part, mm	2650	Max Free Fall Height, PLAY, mm	1000
Netto Weight, Total Shipping Weight, kg	230.64	Minimum Space/Height, mm	2610
Foundation Type	Deep mounting	Safety Area, Length, mm	3120
Heaviest part, kg	29	Width, mm	4170
Falling Space, Length, mm	6590	Falling Space, Width, mm	5600
Falling Space, m2	31	Length, mm	3370
Height, mm	2110	Safety Area, Width, mm	3120
Impact Area, m2	6		

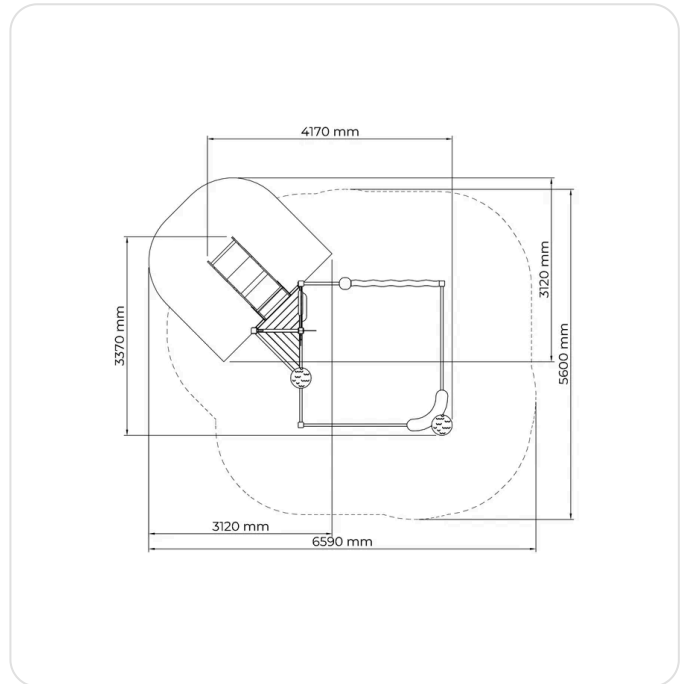
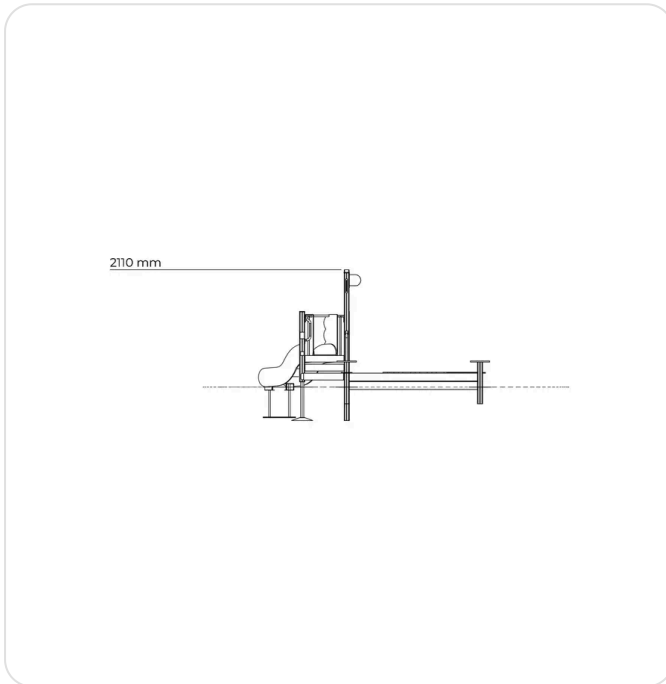

i Installation instructions: <https://lap-integrations-prod.azurewebsites.net/api/pim/installation-instructions?productN...>

i Read more about installation: <https://www.lappset.com/en-GB/playground-installation>



General warranty information

- **20 years:** Steel components and high-pressure laminate (HPL)
- **15 years:** Wooden posts
- **10 years:** Surface finish of steel and aluminum, and hot-dip galvanized surface treatment
- **10 years:** Guaranteed availability of spare parts
- The general warranty terms do not apply to third-party products.
- This overview covers the main warranty periods for Lappset's key materials.



For full details and specific terms or limitations, please see the complete warranty conditions [here](#).

 Read more about warranty: <https://www.lappset.com/en-GB/warranty>

Wooden posts

-  Premium brown
-  Preserved pine, natural tone
-  Platinum grey

Metal parts

-  Ivory white RAL 1013
-  Lemonade yellow RAL 1018
-  Gravel grey RAL 7013

Walls/HPL parts

-  Lake blue RAL 5009
-  Lemonade yellow RAL 1018
-  Moss green RAL 6021
-  Terracotta red RAL 8004
-  Platinum grey NCS S4005-Y50R